

ROWAN DECORATIVE MIRROR

luca+lex

DMMB3, DMBN3, DMBB3

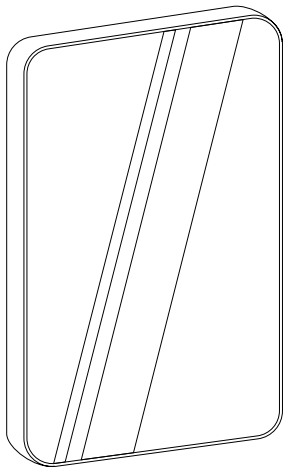

INCLUDED HARDWARE

Wall Anchors, Screws



X4

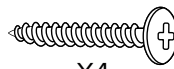

X4

TOOLS YOU MAY NEED:

Phillips head screwdriver, Hammer
Pencil, Level, Tape Measure, Drill

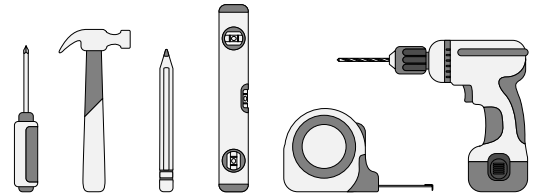

STEP 1:

- Locate hanging hardware before discarding any packaging.
- Determine installation location. For best results, always install mirror into one or more wall studs. When a stud is not available, use wall anchors.

STEP 2:

- Measure and determine location for anchors and/or screws to align with hangers attached to the mirror backing to insure it is level and center.
- Mark the anchor and/or screw placement.

STEP 3:

SOLID WOOD OR STUD MOUNT:

- Fasten screws into wall in marked location leaving enough of the screw head exposed to fit in hangers attached to back of mirror.

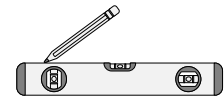
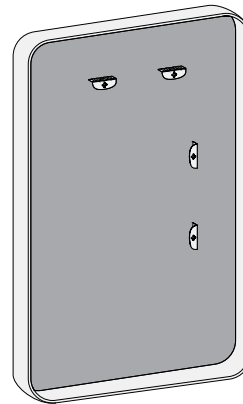
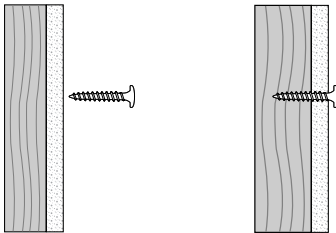

DRYWALL MOUNT:

- Drill pilot holes and insert plastic anchors into drilled holes using hammer to tap the anchors flush with the wall. Be careful when hammering not to damage the anchor or surrounding wall.
- Fasten screws into anchors leaving enough of the screw head exposed to fit in hangers attached to back of mirror.

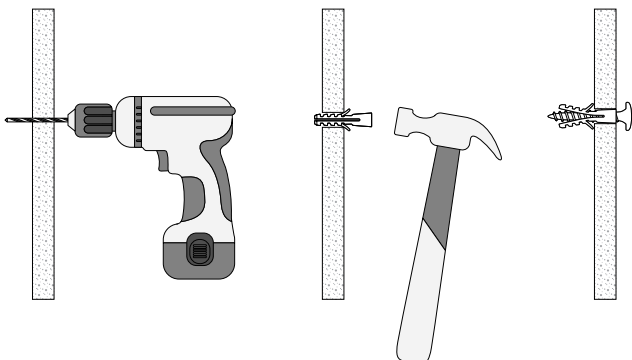

STEP 4:

- Hang mirror on exposed screw heads.

