

# LAUREL DECORATIVE MIRROR

luca+lex

DMMB6, DMBN6, DMBB6

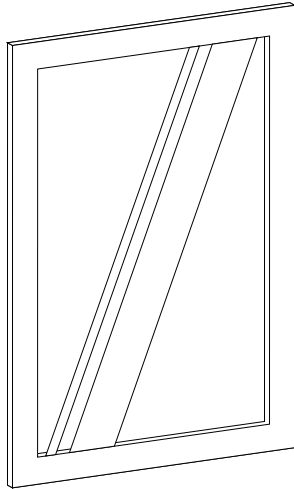

## INCLUDED HARDWARE

Wall Anchors, Screws  
Wall Mount Bracket



X3

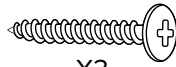

X3

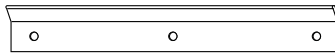

X2

## TOOLS YOU MAY NEED:

Phillips head screwdriver, Hammer  
Pencil, Level, Tape Measure, Drill

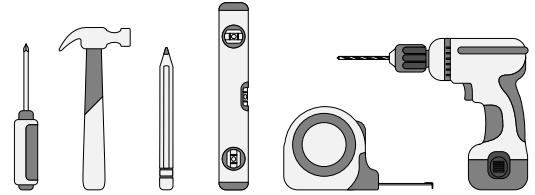

### STEP 1:

- Locate hanging hardware before discarding any packaging.
- Determine installation location. For best results, always install mirror into one or more wall studs. When a stud is not available, use wall anchors.

### STEP 2:

- Measure, level and center the mounting bracket in desired location on the wall in direction shown.
- Mark the anchor and/or screw placement using a pencil through the wall mount bracket.

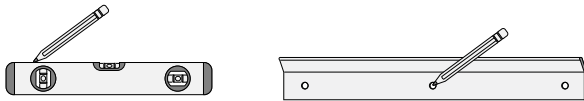

### STEP 4:

- Hang mirror on wall mount bracket using the coordinating bracket already attached to the mirror frame.
- Once securely on the wall mount bracket, mirror can be moved slightly left or right on the bracket to center.

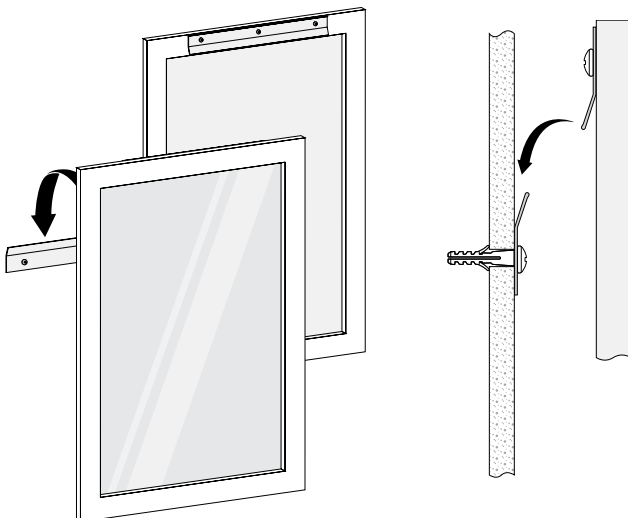

### STEP 3:

#### SOLID WOOD OR STUD MOUNT:

- Fasten screws through wall mount bracket.

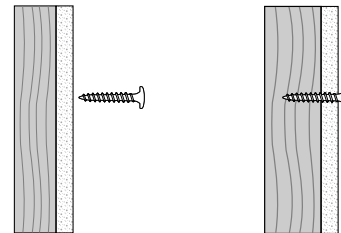

#### DRYWALL MOUNT:

- Drill pilot holes and insert plastic anchors into drilled holes using hammer to tap the anchors flush with the wall. Be careful when hammering not to damage the anchor or surrounding wall.
- Position wall mount bracket over installed anchors.
- Fasten screws through wall mount bracket into anchors.
- Make sure to follow these steps for all holes in wall mount bracket for secure installation.

